

LIFEBREATH®

HEAT RECOVERY VENTILATORS (HRVs)

OWNERS OPERATION & INSTRUCTION MANUAL

IMPORTANT
Manual is to
remain with HRV

Models 100DEF, 100FN

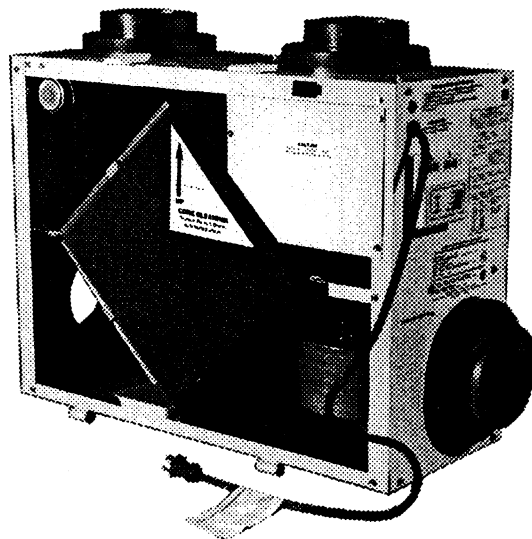

APPLICATION WARNING!!!

It is always important to assess how the operation of any Heat Recovery Ventilator may interact with vented combustion equipment (i.e., Gas Furnaces, Oil Furnaces, Wood Stoves, etc.)

NEVER install a Heat Recovery Ventilator in a situation where its normal operation (including defrost function), lack of operation or partial failure may result in the backdrafting or improper functioning of vented combustion equipment!!



**Do Not Attempt Installing Unit
Without First Reading Entire Manual**

TI-69
9503

INTRODUCTION

This Heat Recovery Ventilator (HRV) is designed to provide fresh air into the dwelling while exhausting an equal amount of stale air. During the winter months, the incoming cold fresh air is warmed by utilizing the heat recovered from the stale air before it is exhausted to the outdoors. During the summer months, the cool outgoing stale air from the air conditioned dwelling is used to help cool the incoming fresh air.

Your HRV features the digital electronic BASE MODULE that uses a microprocessor to control fan speed and unit operation.

Both digital (3 wire) and standard (2 wire) remote devices can control the HRV when connected to the BASE MODULE.

TOOLS REQUIRED

The following is a list of tools you may require for the installation of your Heat Recovery Ventilator:

- Reciprocating Saw
- Electric Drill
- Flat Srewdriver
- "Robertson" screwdrivers #2, 3 (square)
- Philips for straps
- Hex head for sheet metal and electrical box
- Pencil
- Extension Cord
- Measuring Tape
- Knife
- Duct Tape
- Hammer
- Pliers
- Crimpers
- Snips (hand shears)

**For Technical
Information
Call
NUTECH
Service Dept.
(519) - 457-1904**

TABLE OF CONTENTS

Tools Required	1
Engineering Data	2
Operating Your Heat Recovery Ventilator.....	3
Figure #1	
A. Base Module Display Panel.....	3
B. Connection to the Base Module.....	3
Operating the Base Module.....	4
Operating Your Digital Electronic Timer.....	5
Optional Remote HRV Controls.....	6
HRV Control System.....	7
Location for Mounting the HRV.....	8
Figure #2	
Model 100 Schematic.....	8
The Ductwork System	8
A. Outside Weatherhoods	9
B. Ducting from Weatherhoods.....	9
Figure #3	
Weatherhood Installation.....	9
Fresh Air Supply System	10
Figure #4	
Techgrille.....	10
In-Line Duct Heater	10
Stale Air Return System	10
Electrical Connections	11
Air Flow Balancing	11
Other Installation Methods.....	12
Figure #5	
Direct Connection of HRV.....	12
Figure #6	
Independant HRV System.....	12
Figure #7	
Direct Connection to Furnace.....	13
Figure #8	
Direct Connection of both Supply and Exhaust Ducts to Cold Air Plenum.....	13
Filtration and the HRV.....	14
Trouble Shooting Your HRV.....	15
Dimensions.....	16

ENGINEERING DATA

CORE

Single patented aluminum heat recovery core for efficient crossflow ventilation. Meets the flame spread and smoke developed classifications of the National Building Code and NFPA 90A (1993 Edition)

MOTORS

MODEL 100DEF - Two shaded pole motors.
MODEL 100FN - Two high efficiency PSC.

FILTERS

Washable air filters in exhaust and supply air streams.

BLOWERS

Centrifugal type rated at 85 CFM when installed at .2 IN WG. Each air stream has 1 motor driving 1 centrifugal fan.

CONNECTION DUCT SIZES

Four (4) - 5" (125 mm) Diameter

UNIT DIMENSIONS

Length 24.0" (600 mm)
Width 10.5" (262.5 mm)
Height 18.5" (462.5 mm)
Weight 52 lbs. (23.6 kg)
Shipping Weight 56 lbs. (25.4 kg)

MOUNTING

Four (4) - 10/24" (10.5 mm) threaded inserts at corners of case
Four (4) - PVC reinforced polyester straps

CASE

20 gauge prepainted galvanized steel (G60) for superior corrosion resistance. Insulated with foil faced fiberglass duct liner where required to prevent exterior condensation. Drain connection, 1 - 1/2" (12mm) O.D.

OPTIONAL

IN-LINE DUCT HEATERS

Often used to temper the HRV supplied fresh air back up to room temperature (or higher). Built-in thermostat. Available in 6" and 7" duct sizes in both 1 and 2 kilowatt.

CODES and STANDARDS

- CSA Approved.
- R2000 Approved.
- All components are UL listed.
- All units conform to ETL standards.
- HVI Certified.

CONTROLS

- BASE MODULE digital control unit.
- RUN/DEFROST light is illuminated green when HRV is energized and shows red when HRV is in DEFROST mode.
- 4 illuminated speed indicators.
- 5 speed motor controlled by autotransformer (4 lower speeds plus HIGH).
- Override of BASE MODULE setting to HIGH speed operation by low voltage (12 VAC) remote device.
- Standby mode for remote activation of HRV.
- Lockout mode to disable operation of HRV.

DAMPER DEFROST

The Models 100DEF and FN have an electronically controlled damper defrost mechanism. If the outside temperature drops to where frost will begin to form on the core, the defrost system is activated. The HRV digital control system activates a motor driven damper door mechanism which opens the defrost port while at the same time closing off the supply air from outside. After the defrost interval, the damper operates in the opposite direction to close off the defrost port and reopen the fresh air at the supply port.

The advanced programming of the control unit permits a stepping of the defrost cycle with a lengthening of the defrost time and a shortening of the run time as the outside temperature falls. A check of the defrost mechanism is part of the "self test" feature of the control unit. To activate "self test" unplug the HRV for 30 seconds. Hold down the Fan Control Pad and energize the HRV. The unit will cycle through its speeds and defrost damper operation, leaving the unit operating in speed 2.

LIFEBREATH

Operating your Heat Recovery Ventilator

Recent advancements in digital control engineering have permitted easy operation of your ventilation unit's many unique features.

Figure 1

A) The Heat Recovery Ventilator Base Module - Display Panel

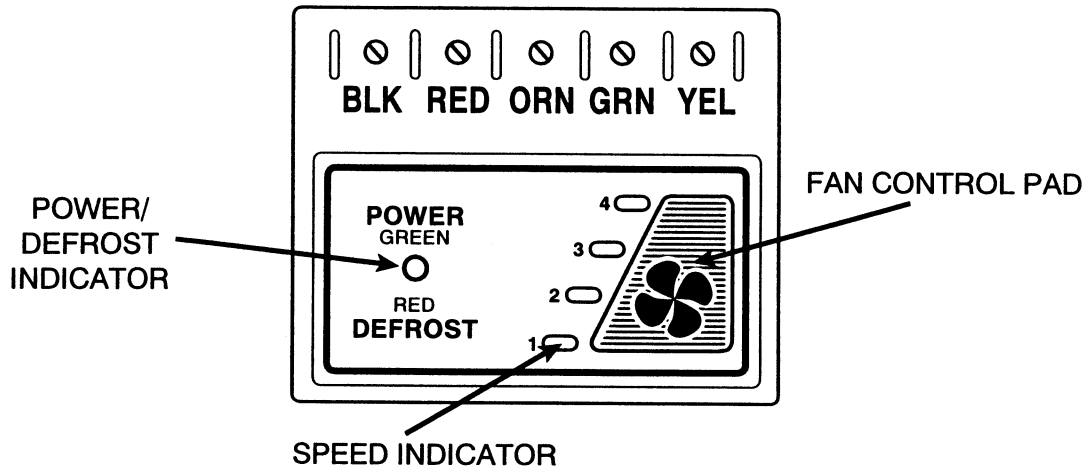

B) Connection of Devices to the Base Module

It is important to note that the Base Module uses a low voltage 12 volt AC system. No external power sources are to be connected to this unit.

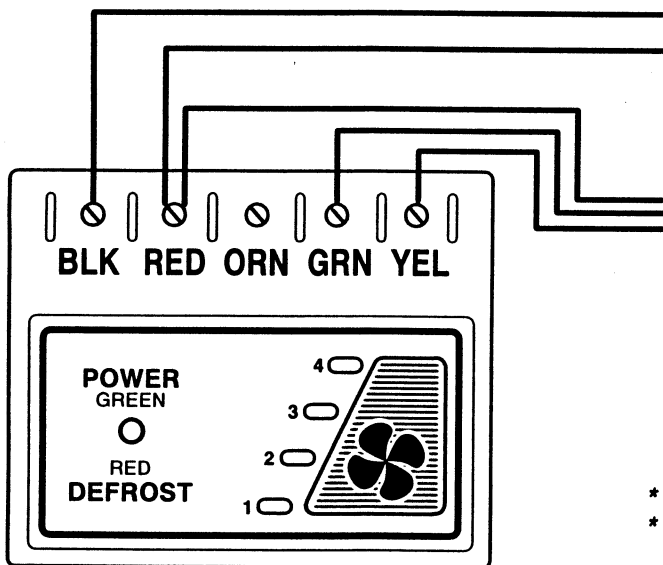

Two Wire Control Devices

- Dehumidistat - Remote
- Mechanical Timer Switch
- Time Control Clock

Three Wire Control Devices

- Digital Electronic Timer
 - Deluxe Programmable Control
 - AIR SENTRY™ Air Quality Sensor
-
- Dehumidistat Ventilation Control (HRV is off when control is in the OFF position) - connects to Black, Red & Orange

* Digital control devices can be mounted as far as 60 feet from the HRV.

* Before connecting OR disconnecting the Digital Electronic Timer or any device to the Base Module, disconnect the HRV from the power source.

It is recommended that remote devices are connected to the Base Module with 3 wire bell wire (22 gauge) or the equivalent.

OPERATING THE BASE MODULE USING THE DISPLAY PANEL

1. Speed Selection

Plugging in the power cord will energize the unit. The fan immediately operates, starting on speed 2. The speed indicator will illuminate yellow.

- The fan speed is changed by pressing the fan control pad. Each time the control pad is pressed, the fan speed will increase to the next higher fan speed. This will be indicated by the illumination of the corresponding yellow speed indicator. This sequence will continue until speed 4 is reached. Pressing the control pad again will cause the fan to turn off. The POWER/DEFROST indicator flashes green and the unit is in STANDBY mode. In STANDBY mode, high speed fan operation can be initiated by the activation of an optional remote device, manual override or operation of the unit's internal dehumidistat. It is possible for the DEFROST cycle to be initiated by cool supply air which will activate the high speed fan while the HRV is in STANDBY mode.
- Press the fan control pad again to resume ventilation in speed 1. The speed indicator will illuminate yellow.
- Remote control devices such as the Digital Electronic Timer, Digital Programable Control, AIR SENTRY™ air quality sensor or Dehumidistat will activate high speed fan operation whether the unit is on one of the available four speeds or in STANDBY mode. These remote devices will override the setting on the Base Module, jumping the unit to high speed. The yellow fan speed indicator light will flash during override.

HRV Operation with a built-in Dehumidistat

- For units equipped with a built-in dehumidistat, the fan will operate at high speed and the yellow speed indicator will continue to flash when the control calls for dehumidification.

2. Automatic Defrost Operation

The advanced technology of the digital base module and onboard microprocessor automatically activates the defrost system only as it is needed. To be an efficient heat recovery device, the HRV must effectively provide for core defrost as well as providing efficient heat exchange. As outdoor conditions cool, the solid state thermistor tracks the supply air temperature and the HRV uses only that defrost cycle time required to clear the core. The core is defrosted by recirculated exhaust air.

This dramatic advance makes more energy available for recovery as the unit spends less time in defrost mode. By optimizing the defrost cycle, the HRV combines money saving performance and a well designed and reliable control system. The POWER / DEFROST indicator is illuminated RED during the defrost cycle.

3. Lockout Mode

(1) Lockout Mode of the HRV Base Module

Pressing and holding the fan control pad for five seconds will put the unit in LOCKOUT mode. All remotes are disabled. The POWER/DEFROST indicator remains illuminated solid GREEN.

If the optional 3 light DIGITAL ELECTRONIC TIMER is pressed while the unit is in LOCKOUT mode, the 20 minute indicator will light momentarily and the DIGITAL ELECTRONIC TIMER will not function.

To return the unit to normal operation, press and hold the fan control pad on the HRV Base Module for five seconds or interrupt the power supply to the unit for 15 seconds. The fan will now operate normally.

Glossary

STANDBY MODE -the HRV is energized and waiting for fan operation to be initiated by a remote device or manual override.

DEFROST MODE -to ensure reliable operation during cold weather, the HRV will automatically cycle through its defrost mode as needed.

LOCKOUT MODE OF THE HRV BASE MODULE - using this mode disables the operation of the base module and any remote device connected to the Base Module.

LOCKOUT MODE OF THE REMOTE DIGITAL ELECTRONIC TIMER

- (A) The remote timer can be set to defeat further timer activity.
- (B) The remote timer can be set to stop further changes of the run time **selected** at that timer.

DEHUMIDISTAT - a control device that senses the amount of moisture in the air and will activate high speed fan operation when the air moisture level exceeds the control setting. The optimum air moisture level (or relative humidity [Rh]) in the typical home is in the range of 30 to 40% Rh.

RE-SET THE HRV - whenever re-setting of the base module / microprocessor is required, simply unplug the HRV for 30 seconds.

OPERATING YOUR DIGITAL ELECTRONIC TIMER

DIAGRAM 1
DIGITAL ELECTRONIC TIMER (DET)

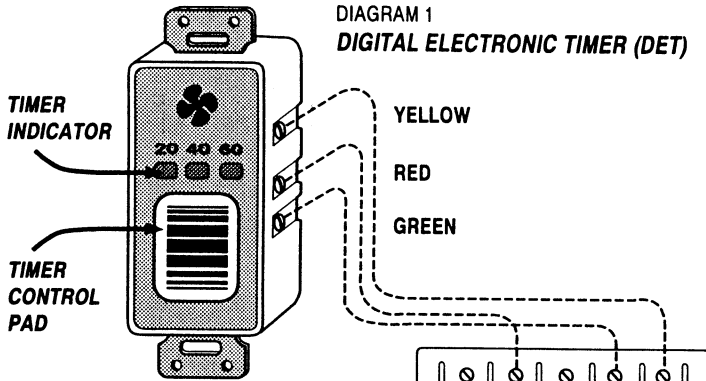

DIAGRAM 2
BASE MODULE
CONNECTION OF
DIGITAL ELECTRONIC TIMER

BASE MODULE

= TIMER INDICATOR = TIMER CONTROL PAD

1. Features

- **Easy to operate**
 - Simply press the Timer Control Pad
 - Illuminated display indicates timer status
- **Easy to install**
 - Mounts in a full or 1/2 depth electrical box
 - Connect Timer with 3 wire Bell wire (22 gauge) to the BASE MODULE of your Heat Recovery Ventilator
- Permits remote high speed fan operation of the HRV when it is operating in one of the four lower speeds or when it is in STAND BY mode.
- Child LOCKOUT Mode

2. Operating Your Digital Electronic Timer

Press once. The 20 minute illuminates yellow.

When the is illuminated, the Heat Recovery Ventilator is operating on high fan speed.

Press again and the 40 minute illuminates yellow. Press again, the 60 minute illuminates.

Press again, the are extinguished. The Timer is now off.

The Timer can be activated by pressing the again.

***NOTE: HRV has a 15 second time delay**

3. Timer Display Status

The indicator lights show Timer activity. If the Timer is set for 60 minutes, the 60 minute Timer is illuminated for 20 minutes and then cascades to the 40 minute . With the passing of the next 20 minutes, the unit will then cascade to the 20 minute . The 20 minute will then remain illuminated until the last 5 minutes when the will begin to flash. Once the set time has elapsed the is extinguished, and the Timer turns OFF.

4. LOCKOUT MODE -TO PREVENT CHILDREN FROM PLAYING WITH THE CONTROL

(A) The Digital Electronic Timer can be set to defeat further activity at this remote.

***The Timer is not active and none of the indicators are illuminated.**

1. Press and hold for 5 seconds. The 20 minute will begin to flash yellow.
2. Release . The flashing will be extinguished.
3. Now the timer will not operate. If you press , the 20 minute will light momentarily. The HRV will not be affected by the timer.
4. To reactivate the Digital Electronic Timer, press and hold for 5 seconds. The 20 minute will flash yellow. Release and the remote now is able to activate the HRV.

(B) Setting the Digital Electronic Timer to stop further changes of the selected run time, at this remote.

*** The timer has been activated and is currently operating with one of the 20/40/60 illuminated.**

1. If one of the 20/40/60 minute is illuminated, press and hold for 5 seconds, the 20 minute will flash.
2. Release , the 20 minute will stop flashing and the previously set time will be illuminated at 20/40 or 60 min.
3. While the timer is in LOCKOUT mode, further pressing of will only cause momentary illumination of the 20 minute . The HRV will continue to operate on high speed until the indicated time has elapsed. The timer will turn off and the HRV will resume operation at the speed setting indicated at the BASE MODULE.
4. The timer LOCKOUT mode can be defeated and normal operation of the Timer will resume if the is pressed and held for 5 seconds. The 20 minute will flash. The timer will now illuminate the 20/40/60 minute that was illuminated before the remote timer was put in LOCKOUT mode.

IMPORTANT - Base Module Low Voltage is 12 Volt AC. Do not connect external power sources to unit.

OPTIONAL REMOTE HRV CONTROLS

A Family of Innovative Digital Remote Devices

DIGITAL ELECTRONIC TIMER

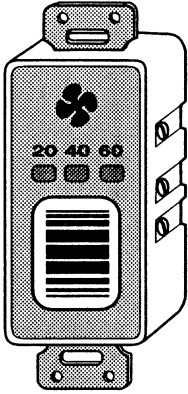

Easy to operate and simple to install, makes the perfect bathroom and kitchen ventilation control.

- Touch pad for 20/40/60 minute operation
- A simple press activates high speed
- Timer easily turned off with a touch
- 3 indicator lights display timer status
- Compact unit for convenient wallmount
- Childproof **LOCKOUT** feature
- Available decorator plates in White, Ivory or Grey

Digital Electronic Timer #99-104 OR

Digital Electronic Timer Kit #99-108W, 99-108I, 99-108G

complete with decora cover plate, 60'(18.2m) 3 wire cable (22 gauge)

DIGITAL PROGRAMMABLE CONTROL

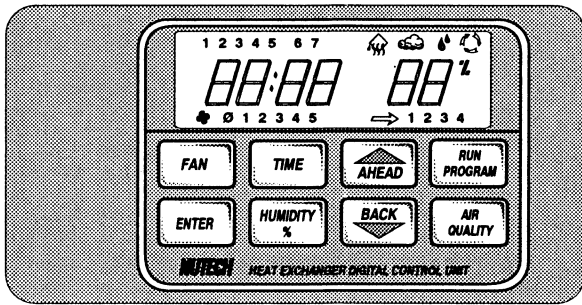

Advanced digital remote control permits programming of HRV functions and features:

- 7 day programmable electronic time clock (battery backup)
- Programmable dehumidistat
- Air Sentry™** air quality sensor
- Easy to use 8 key control pad
- Fan and speed control
- Digital display of humidity, time and speed
- HRV operation is clearly indicated by status lights

Digital Programmable Control #99-105 (Available May '95)

includes 60'(18.2m) 3 wire cable (22 gauge)

AIR SENTRY™ AIR QUALITY SENSOR

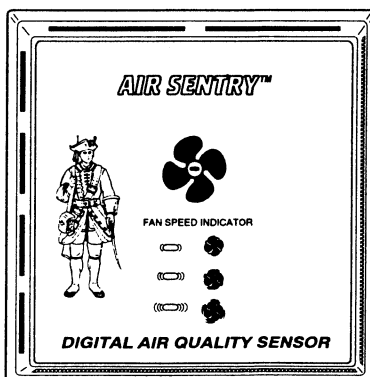

The **Air Sentry™** remote is an air quality monitoring device, sampling the indoor air and capable of activating high speed operation of the HRV.

- Digital sensor monitors air quality
- Status light indicates sensor has been activated
- Speed of light blinking indicates higher fan speed
- When activated it provides increased ventilation to remove odours and contaminants
- Among the gases detected by the semiconductor gas sensor are carbon monoxide, formaldehyde and cigarette smoke

Air Sentry™ Kit #99-109 *complete with 60'(18.2m) 3 wire cable (22 gauge)*

**This is not designed to be a carbon monoxide alarm*

CONNECTIONS AND DEVICE LOCATION

DIGITAL DEVICES

Three Wire Control Devices

Low Voltage

12 Volt AC System

DIGITAL ELECTRONIC TIMER

AREAS: Bathrooms & kitchens

- Touch pad operation
- 20/40/60 minute status lights
- Compact wallmount unit
- Childproof lockout feature (99-104)
- c/w Decor plate and cable (60" (18.2 m)) (99-108) Indicate Ivory/ White/ Grey

DELUXE PROGRAMMABLE CONTROL

AREAS: Hallway, kitchen, office & workplace

- Advanced digital remote
 - Programmable dehumidistat
 - AIR SENTRY™ air quality sensor
 - 7 day electronic time clock
 - Digital display and status lights (99-105 includes cable 60' (18.2 m))
- Available Spring '95

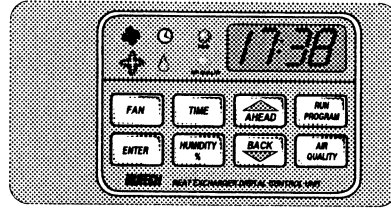
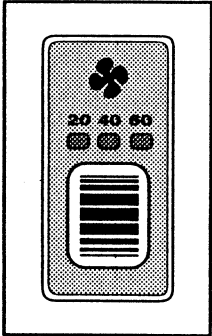

AIR SENTRY™ AIR QUALITY SENSOR

AREAS: Kitchen, basement, workplace

- Digital Air Monitor
- Status light indicates activity
- Increases ventilation to remove odours and contaminants
- Among gases detected are carbon monoxide and formaldehyde c/w 3 wire cable 60' (18.2 m) (99-109)

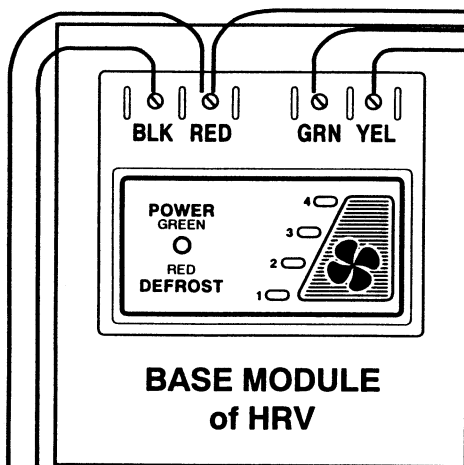
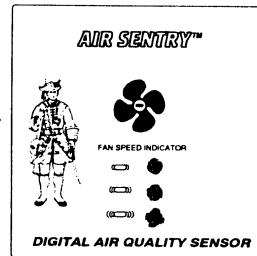

3 wire Bell wire
(22 guage)
Keep lengths to 60 feet
(18.2 m) or less

Two Wire Control Devices Low Voltage

DEHUMIDISTAT

AREAS: - kitchen
- bathroom
- spa
- swimming pool area
- anywhere where humidity is a concern (99-103) White or Beige

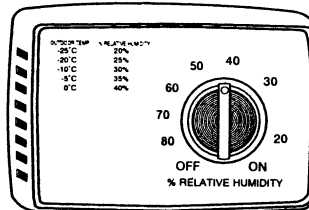

TOGGLE SWITCH

- accessible for high speed ventilation

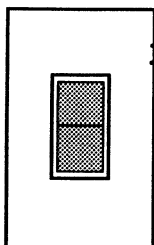

CRANK TIMER OR TIME CLOCK

AREAS: - bathroom
- in office or classroom to bring on high speed ventilation as required
Crank Timer - 60 minute (99-101)

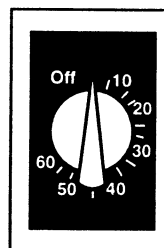

LOCATION for MOUNTING

The Heat Recovery Ventilator must be located in a heated space where the surrounding air temperature does not fall below the freezing point. This is to prevent freezing of the condensate lines. It is also very important that the unit be mounted level (horizontal) in order that the proper condensate drainage can occur. Failure to do so will void warranty.

Typically, the HRV is positioned in the mechanical room or area close to the outside wall on which the weatherhoods will be mounted. Remember it needs a 120 VAC outlet to plug into (extension cords should not be used except if required to test unit on initial startup). If a basement area is not convenient or does not exist, a utility or laundry room may be used. Attic installations are not normally recommended due to complexity of work to prevent freezing while allowing access for service and cleaning.

Sufficient clearance to the front of the HRV is required for servicing of the air filters and exchange cores. A minimum of 25 in. (625 mm) clearance is recommended.

The four PVC reinforced polyester straps supplied are for mounting the HRV to the basement floor joists. The hanger straps should be attached to the unit at the top end corners (mounting screws already located on the HRV case). Securely fasten the other end of the straps to the floor joists with wide head nails (not supplied) making sure unit is level. The rubber straps are designed to reduce the possibility of noise, resonance or harmonics, therefore using the full length between the HRV and the floor joists is recommended.

There is a prepunched hole in the bottom of the HRV through which protrudes the drain pan connector. See Figure #1 for proper placement of the drainage hose. The drain line must be located in an area that is not subject to freezing and should be outletted into floor drain sink, standpipe or condensate pump. Make sure the drain line slopes down to provide proper condensate removal. Should no "fall" be available, a condensate pump may be used.

NOTE: A P-Trap must be made to prevent odours from being drawn in through the drain line.

THE DUCTWORK SYSTEM

A well designed ducting system will allow the HRV to operate at its maximum efficiency. Air flow will be restricted by undersized ducting, use of too many elbows, tees, bends, etc. Always try to keep duct runs as short and straight as possible. When in doubt about the airflow capacity of a duct's diameter, always install the next larger size of duct.

NOTE: Fully insulated ducting with an integral vapour barrier must be used on all runs passing through unheated areas in order to avoid condensation problems and energy losses from the air streams. We recommend that a high quality of insulated flex duct be used.

Four 5 in. (13 cm) ports on the HRV are for attachment to the ductwork system. See Figure #2 for the function of these ports.

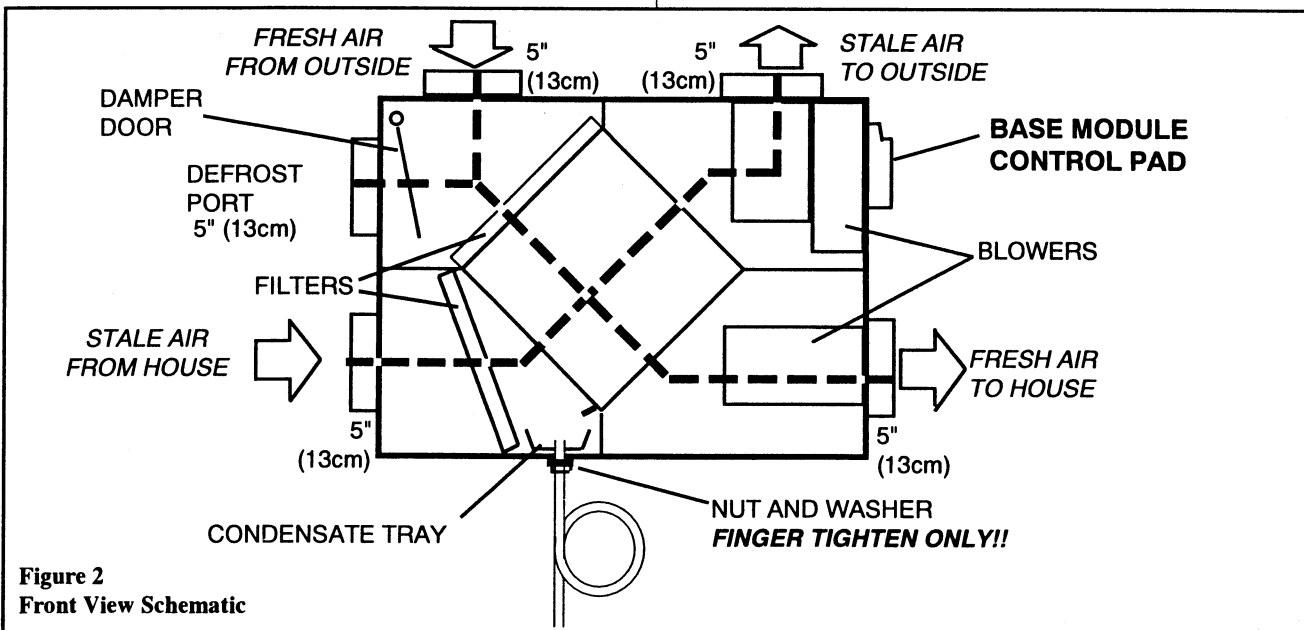

Figure 2
Front View Schematic

A**OUTSIDE WEATHERHOODS**

The weatherhoods must have built-in "bird" screens with 1/4 in. (.635 cm) minimum mesh to prevent foreign objects from entering into the ductwork. Do not use smaller mesh as it will be very susceptible to plugging up. Flappers and dampers at the vents must not be used as they will restrict air flow and often "seize up". The preferred location of the outside weatherhoods is:

- no less than 6 ft. (2 m) apart from each other
- at least 18 in. (25 cm) above ground level
- away from sources of contaminants, such as automobile exhaust fumes, gas meters, garbage cans, barbecues, etc.
- not exposed to prevailing winds, whenever reasonably possible

The outside perimeter of the weatherhood must be caulked.

B**DUCTING from the WEATHERHOODS**

Five inch (13 cm) diameter insulated duct with an integral single piece vapour barrier should be used. **Duct must meet ULC Class 1 fire rating** (or UL Class 1- check codes).

A minimum RSI value of insulation should be equal to 0.75 (R4), or that of the local building codes.

The inner and outer liners of the flexible insulated duct must be clamped to the sleeve of the weatherhood (as close to the outside as possible) and the appropriate port on the HRV. To keep the insulation and outer liner in place, a clamp and duct tape must be used. It is very important that the fresh air intake line be given special attention to make sure it is well sealed. A good bead of high quality caulking (preferably acoustical sealant) will seal the inner flexible duct to both the HRV port and the weatherhood prior to clamping.

To minimize air flow restriction, the flexible insulated duct that connects the two outside weatherhoods to the HRV should be stretched tightly and be as short as possible.

See Figure #3 for the recommended connection of flexible insulated ducts to both the outside weatherhoods and the HRV.

Ducting from the HRV to the different areas in the dwelling is recommended to be galvanized metal whenever possible, though flexible duct can be used if so desired.

WEATHERHOOD INSTALLATION

Figure 3
Weatherhood Installation

WARMSIDE DUCTING-General

Main supply and return lines to/from Heat Recovery Ventilator must be 5 in. (13 cm) minimum. Branch lines to the individual rooms may be as small as 4 in. (10.2 cm), but 5 in. (13 cm) lines are preferred whenever possible.

To minimize airflow losses in the ductwork system, all ducts should be as short as possible and with as few bends or elbows as possible. 45° elbows are preferred to 90° elbows, whenever possible. Use Y tees instead of 90° tees whenever possible.

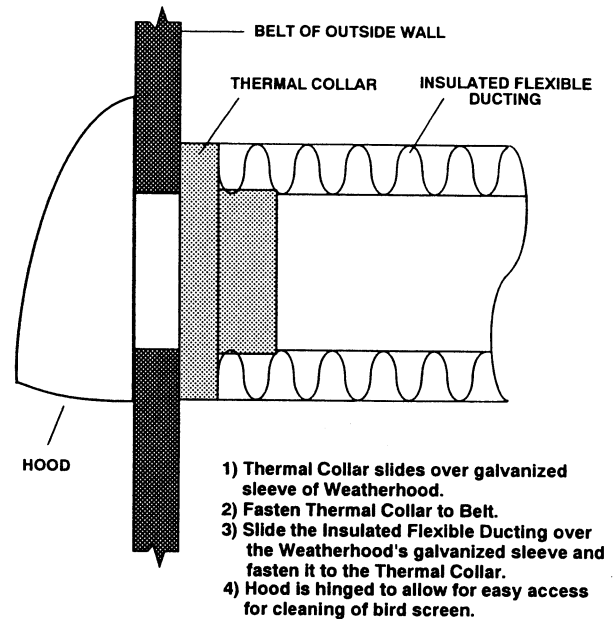
All duct joints must be fastened with screws, rivets or duct sealants and wrapped with a quality duct tape to prevent leakage. We recommend aluminum foil tape.

To avoid possible noise transfer through the ductwork system, a short length approximately 12 in. (30 cm) of non-metallic flexible duct may be connected between the HRV and the supply/exhaust ductwork system. A canvas duct connector can also be used to connect the HRV to the rigid ductwork.

The use of TECHGRILLES™ (from NUTECH) as supply air diffusers and air exhaust covers are recommended. They are efficient, sound absorbing devices specifically designed for this installation.

If a "regular style" steel grille is used, the preferred wall grille size is 5 X 12 in. (13 X 30 cm) and floor grille size is 4 X 10 in. (10.2 X 25 cm). Smaller grille sizes may restrict air flow.

FRESH AIR SUPPLY SYSTEM

INSTALLATION FIGURE #5 & #7

In this method, the supply air is ducted directly into the cold air return of the central forced air furnace.

NOTE: The installation schematics show a balancing damper on the supply duct leaving the unit. This is installed to balance the supply of air from the unit.

Should you wish to hard duct the supply air directly into the cold air return of the furnace, remember to check the air flow balance of the HRV with the furnace fan both "ON" and "OFF" to determine that it does not imbalance the HRV more than 10%. Also, it is advisable to include a short length of fabric flex duct or other non-metallic connector in this hard ducted line in order to keep the HRV separately grounded (electrically) from the furnace. This will avoid a possible shock hazard to Service People if a short to ground develops in one of the devices.

The use of balancing dampers and/or adjustable grilles to balance the flow rates into various rooms is recommended. The TECHGRILLE™, available in 4", 5", 6" (100, 125 and 150 mm) is highly recommended. The TECHGRILLE™ is a round, fully adjustable grille, which provides superior, quiet air distribution. See Fig. 4.

NOTE: Do not use any louvered hoods with installation of LIFE BREATH™ HRV, as this will restrict the required air flow.

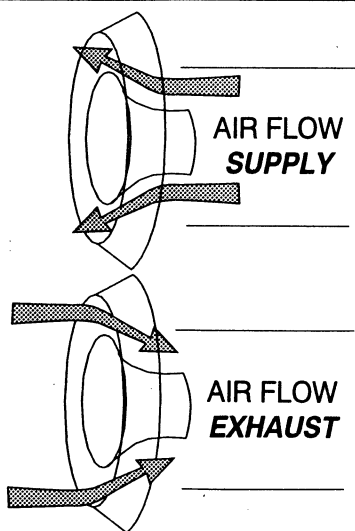

Figure 4
TECHGRILLE™ (Optional) Schematic

The fresh air supply from the HRV to the house can follow several installation strategies. See Figures #5 and #6 for two installation schematics. The installation schematic shown in Figure #5 has proven to be an excellent method for both retrofit and new home situations where a forced air furnace is available. The installation schematic shown in Figure #6 is often installed in new or existing homes that do not have a forced air ducting system to distribute the fresh air throughout the house. For Figure #5, fresh air should be supplied to all rooms, but it is not required in those with exhaust points in them.

Supply air grilles may be floor or high wall mounted, but should not be located in areas where the fresh air will cause an uncomfortable draft on the occupants. TECHGRILLES™ diffuse cool air exceptionally well to avoid drafts. Avoid installing supply air grilles in bathrooms, or any other small room (with significant air quality problems) if it has an exhaust duct.

INDIRECT CONNECTION

If permitted by local codes an indirect connection may be made between the HRV supply duct and the furnace return plenum.

The fresh air from the HRV may be directed at a grille installed in the cold air return duct of the furnace. The fresh air supply outlet from the unit should be no closer than 4 in. (10.2 cm) and no further than 12 in. (30 cm) from the grille.

NOTE: The grille in the cold air return duct must be at least 6 1/2 ft. (2 m) from the furnace, if fossil fueled, or as specified by local regulatory codes.

IN-LINE DUCT HEATER

The In-line duct heater may be used to temper the HRV supply air. The supply air can be heated as desired by using the built-in adjustable thermostat.

A duct heater is usually used when supply air is ducted directly into the space or room. If however, the supply air is ducted from the HRV to a furnace or air handler, it is seldom necessary to incorporate a duct heater into the HRV system.

STALE AIR RETURN SYSTEM

The stale air return system is used to draw air from the points in the house where the worst air quality problems occur. It is recommended that return air ducts are brought back from the bathroom, kitchen, and laundry room. Additional return air ducts from strategic locations (i.e. greenhouse, atrium, swimming pool, sauna, etc.) may be installed. Note that the installation schematics show balancing dampers and/or adjustable grilles on all return air lines coming back to the unit. These are installed to help balance the "draw" from the different areas of the house.

The damper located just prior to the Heat Recovery Ventilator is provided to balance the stale air exhausted out of the house with fresh air supply entering the house.

We recommend the use of high mounted wall returns with grilles. The exhaust air duct from the kitchen should never be connected to a range hood. Instead, an exhaust air grille should be mounted high on the wall at least 4 ft. (1.2 m) horizontally away from the stove. A "flip-up", 6" x 10" (15 x 25cm) rectangular kitchen grille with removable grease filter is available (Part #10-002).

INSTALLATION -FIGURE #7

In this method, the exhaust air is not ducted back to the HRV with "dedicated lines": from bathrooms, kitchens, etc. Instead, the exhaust air is drawn out of the cold air return of the central forced air furnace. This method has become popular and provides good ventilation when installed in accordance with the noted instructions.

ELECTRICAL CONNECTIONS

The 100 series is a 3 prong 120VAC plug in type. If further wiring is required it is recommended that a licensed electrician make all electrical connections. **It is very important that the unit be properly grounded.** It is recommended that a separate 15 amp/120 volt circuit be used.

WARNING: *In order to prevent electric shock when cleaning or servicing the HRV, it is extremely important to confirm the polarity of the power line that is switched by the safety (disconnect) switch whose control arm is located on the outside electrical control box area. The hot line (black) is the proper line to be switched. To confirm the proper polarity, use a voltmeter or test lamp to make sure there is no power after the switch when the door is open. Check between that point and ground (on the cabinet). This must be done as occasionally some dwellings are improperly wired. Always make sure the HRV is properly grounded.*

AIR FLOW BALANCING

It is necessary to have volume balanced air flows in an HRV. The volume of air brought in from the outside must equal the volume of air exhausted by the HRV. If the air flows are not properly balanced, then;

- The HRV may not operate at its maximum efficiency
- A negative or positive air pressure may occur in the house
- The HRV may not defrost properly
- Failure to balance HRV may void warranty

An excessive positive pressure may drive moist indoor air into the external walls of the building where it may condense (in cold weather) and degrade structural components. Also; it may cause key holes to freeze up.

An excessive negative pressure may have several undesirable side effects. In some geographic locations, soil gases such as radon or methane may be drawn into the home through basement/ground contact areas. Radon is believed to be a cause of lung cancer. As well, an excessive negative pressure may cause the backdrafting or backspilling of vented combustion equipment if an adequate combustion air supply is not provided. ***Read the Application Warning at the start of this manual!***

Balancing Procedure:

- A. Five inch (13 cm) diameter flow collars connected to an inclined or digital manometer, magnehelic etc. with a range of 0 to .25 in. (0 to 62.5 Pa) of water are recommended for accurate air flow measurements. To avoid air flow turbulence and incorrect readings, the flow stations should be located at a point at least ten duct diameters, i.e. 5 in. (13 cm) duct requires 10 diameters X 5" = 50" (127 cm) away from the nearest valve or flow restriction. Refer to HRAI installation manual. This requirement applies to both the stale air to exchanger duct and the fresh air to house duct.
- B. Prior to balancing, make sure:
 1. All sealing of the ductwork system has been completed.
 2. All of the HRV components are in place and functioning properly.
 3. Balancing dampers are fully open.
 4. Unit is on HIGH speed (connect Black to Red on Base Module).
 5. Air flows in branch lines to specific areas of the house should be adjusted first prior to balancing the unit. A smoke pencil used at the grilles is a good indicator of each branch line's relative air flow.
 6. After taking readings of both the stale air to the HRV duct and the fresh air to the house duct, the duct with the lower CFM (L/s) [velocity] reading should be left alone, while the duct with the higher reading should be dampered back to match the lower reading.
 7. Return unit to appropriate fan speed for normal operation.

OTHER INSTALLATION METHODS

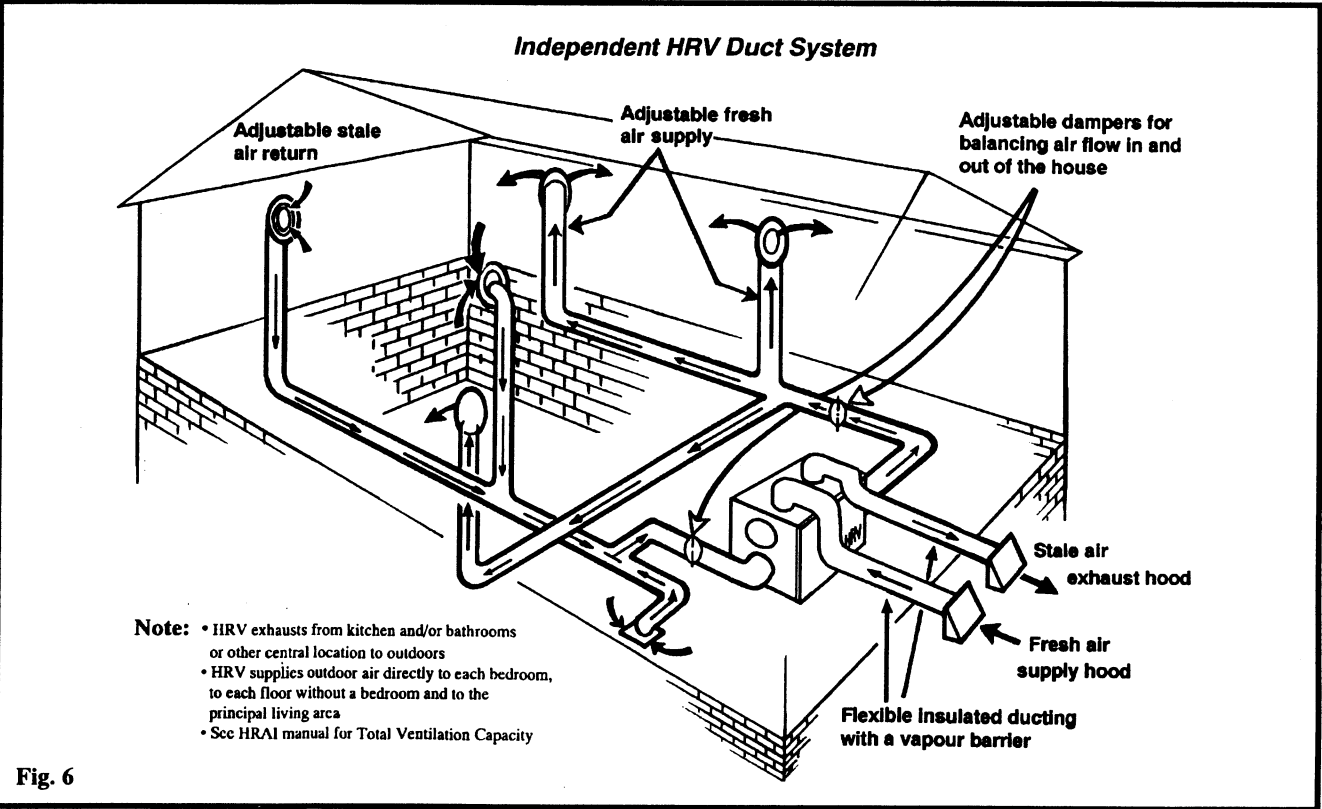
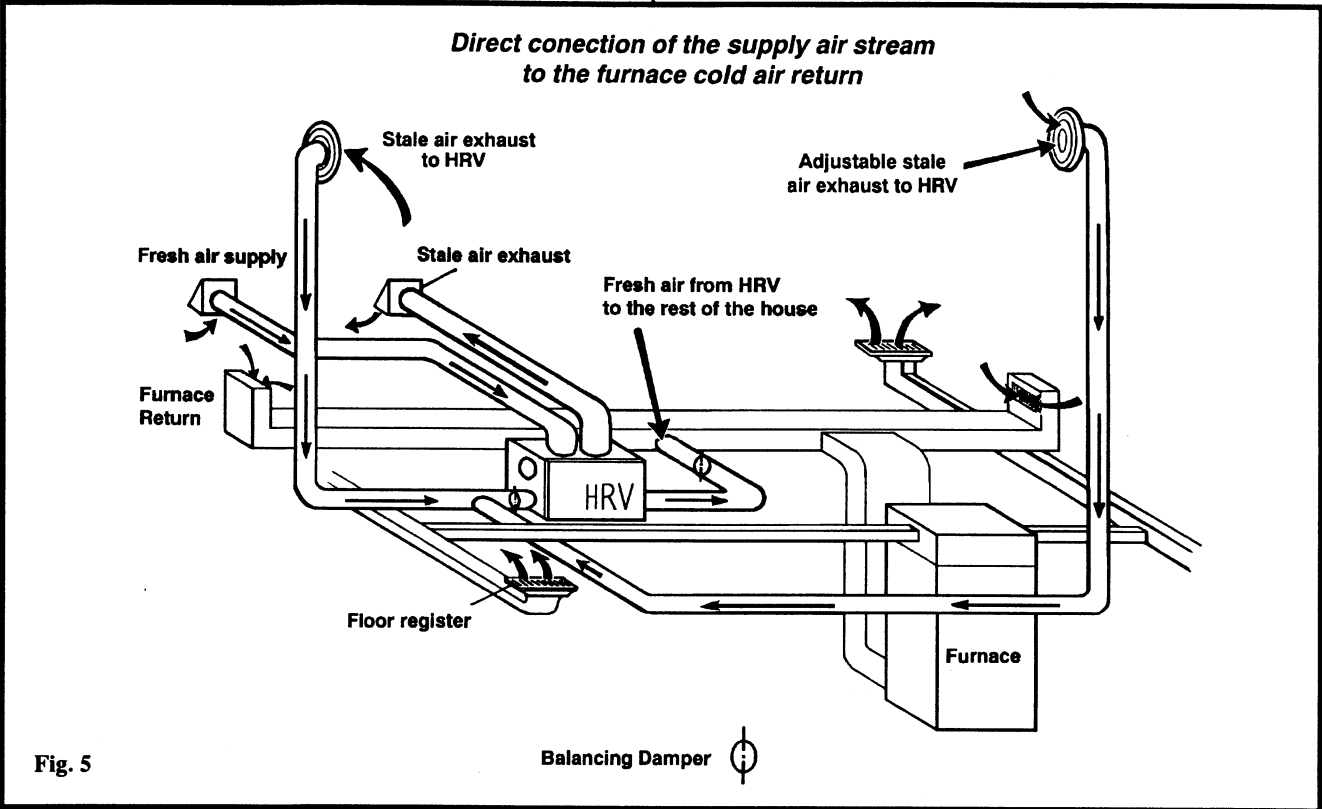

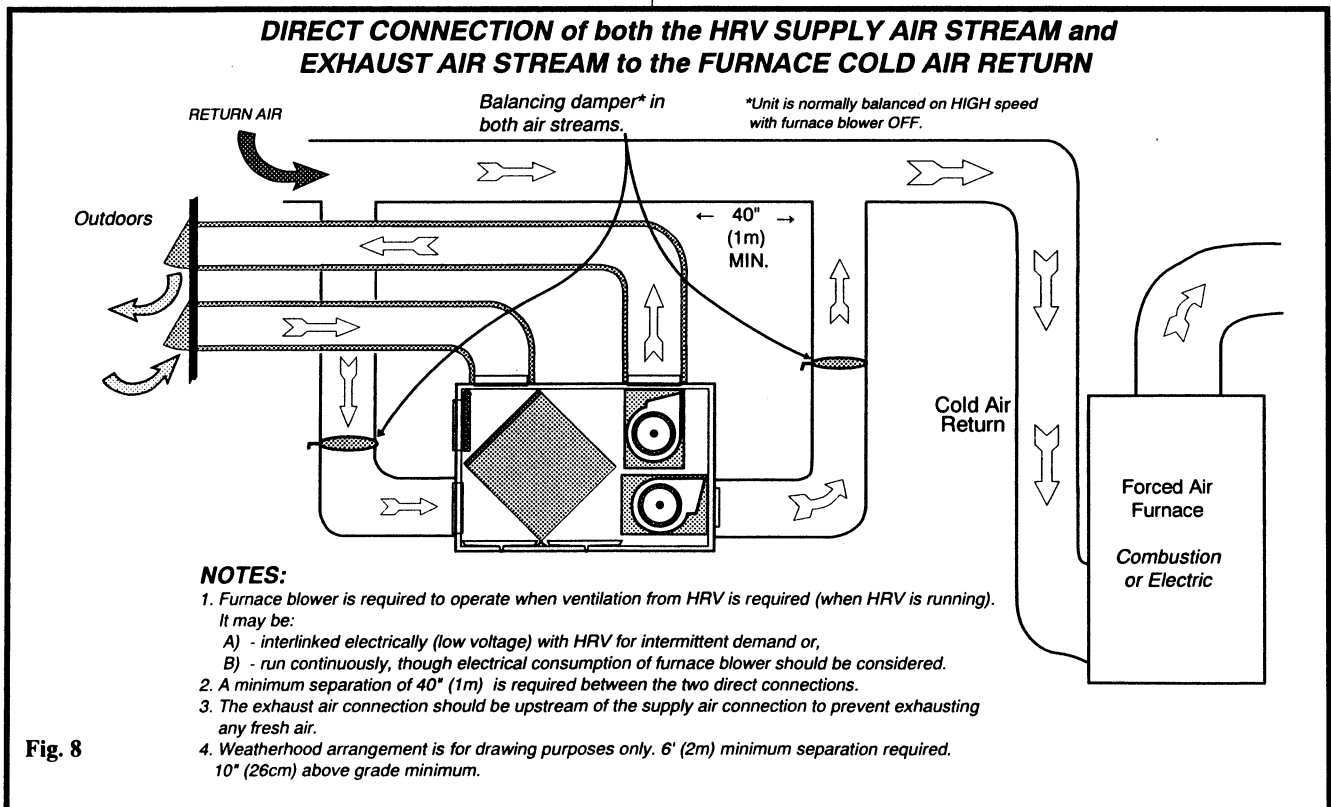
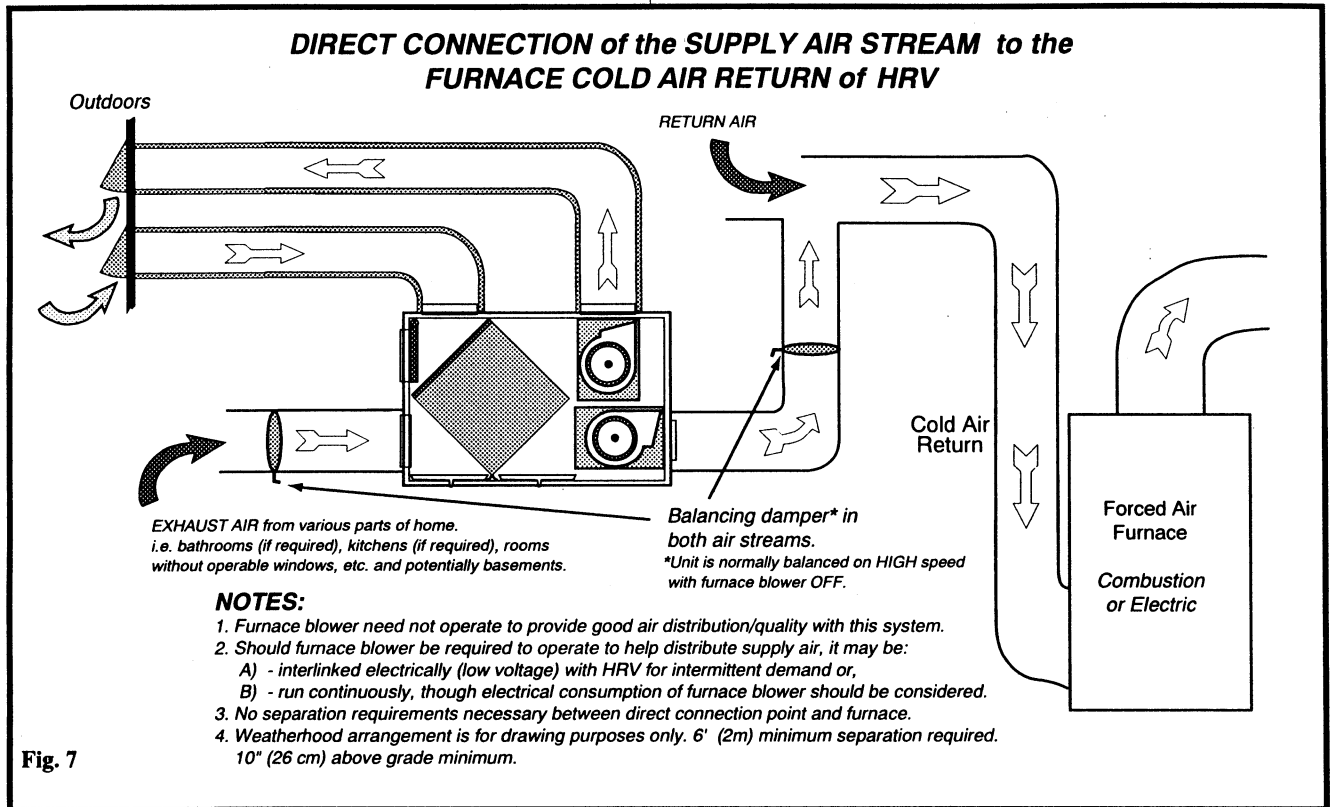

FILTRATION AND THE AIR YOU BREATHE

Filters are used to remove odours and particulates from the airstream. Filters that remove particulates are designed to effectively clean the air by catching materials that collide with its fibers.

PASSIVE filters use a mesh to stop larger particles.

ELECTRONIC polarized media filters work on the principle of passing dust particles through a series of electrically polarized filters. The fibres then attract the dust which sticks to them.

ELECTROSTATIC filters work on the principle of passing dust through a series of plastic fibres which have an electrostatic charge. This charge is induced on the collector plates by the friction of the air passing over them.

CHARCOAL filters effectively remove irritating odours, fumes and airborne chemicals. Smog, smoke and ozone are absorbed.

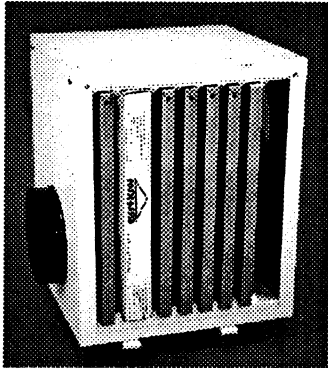

SCRUBBER

AIR TREATMENT SYSTEM

Removes contaminants that enter the home through the ventilating system.
•wood smoke •dust •pollen •outside odours •airborne pollutants

INCLUDES: 1 x Pre filter
5 x Carbon Mesh Filters
1 x 2" Pleated Media Filter

PART # 94-600

OPTIONAL Either the Electronic (99-176) or Electrostatic Air Filter (99-173-AS) may be incorporated into the unit.

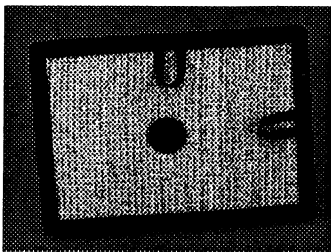

ELECTROSTATIC AIR FILTER

Arrests dusts, pollens and molds in the air stream.

- Durable
- Easily cleaned
- Air moving through the filter produces the electrostatic charge
- Easily inserted into the HRV or SCRUBBER

PART # 99-173 (Special order only for model 100)

NOT FOR USE WITH ELECTRIC DEFROST HRV

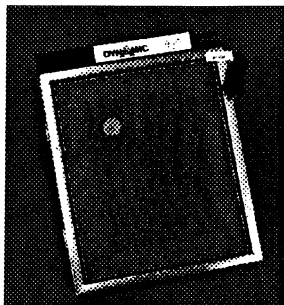

ELECTRONIC AIR FILTER

- Very effective at arresting dust, pollen and molds
- Polarized glass fibre material traps particles
- Very hygienic since glass fibre pillow media is completely replaced.
- Efficient low voltage system
- Complete with replacement media
- Easily installed into the HRV or SCRUBBER

PART # 99-171, 12 volt system (Special order only for model 100)

TROUBLESHOOTING YOUR HRV

SYMPTOM	CAUSE	SOLUTION
Humidity levels too low	<ul style="list-style-type: none"> • HRV air flows improperly balanced • Dehumidistat control set too low • Lifestyle of occupants 	<ul style="list-style-type: none"> • Balance HRV • Set dehumidistat higher • Humidity may have to be artificially added via humidifiers
Humidity levels too high	<ul style="list-style-type: none"> • HRV air flows improperly balanced • HRV undersized initially • Dehumidistat set too high • HRV undersized to handle hot tub, indoor pool etc. • Lifestyles of occupants • HRV not operating or malfunctioning 	<ul style="list-style-type: none"> • Balance HRV • Set dehumidistat • Cover pools, hot tubs etc. when not in use • Avoid hanging clothes to dry, storing wood and venting clothes dryer inside
Timer / Dehumidistat or Remote Device is not Operating	<ul style="list-style-type: none"> • Improper connection to external 12V BASE MODULE • Improper connection of external low voltage wiring between HRV and remote switch • External low voltage is shorted out by a staple, nail, etc. • Malfunction with 12V transformer in HRV 	<ul style="list-style-type: none"> • Check 12V board on HRV to ensure unit able to jump to high speed • Check external wiring for short • Check wall switch for proper connection
HRV and/or Ducts Frosting up	<ul style="list-style-type: none"> • HRV air flows improperly balanced • Back draft dampers not installed or working when HRV is turned off • Malfunction with HRV's defrost system 	<ul style="list-style-type: none"> * Note minimal frost build up is expected on cores before unit initiates defrost cycle function • Balance HRV • Install backdraft dampers
Supply air feels cool	<ul style="list-style-type: none"> • HRV air flows improperly balanced • Poor location of supply grilles • Outdoor temperature extremely cold 	<ul style="list-style-type: none"> • Balance HRV • Locate grilles high on walls or under baseboards • If supply air is installed into return of furnace, furnace fan may need to run continuously to distribute ventilation air comfortably
Water in bottom of HRV	<ul style="list-style-type: none"> • Drain pans plugged • Improper connection of HRV's drain lines • HRV is not level • Drain lines obstructed • HRV heat exchange core not installed properly 	<ul style="list-style-type: none"> • Ensure O-Ring on drain nozzle sits properly • Look for kinks in line • Check water drain connections • Make sure water drains properly from pan
Condensation or ice build up in insulated duct to outside	<ul style="list-style-type: none"> • Incomplete vapour barrier around insulated duct 	<ul style="list-style-type: none"> • Tape all joints • Ensure that vapour barrier is completely sealed
Poor air flows	<ul style="list-style-type: none"> • HRV air flow improperly balanced • Filters/Core plugged up • 1/4" mesh on outside hoods plugged up • House grilles closed • Dampers closed • Poor power supply • Improperly sized ducting • Under sized HRV • Improper speed control setting • Malfunction with HRV 	<ul style="list-style-type: none"> • Tape all joints • Use proper air flow measuring equipment • Open all grilles • Remove obstructions in duct(s), hoods, and grilles • Balance air flows

DIMENSIONS 100DEF inches (mm)

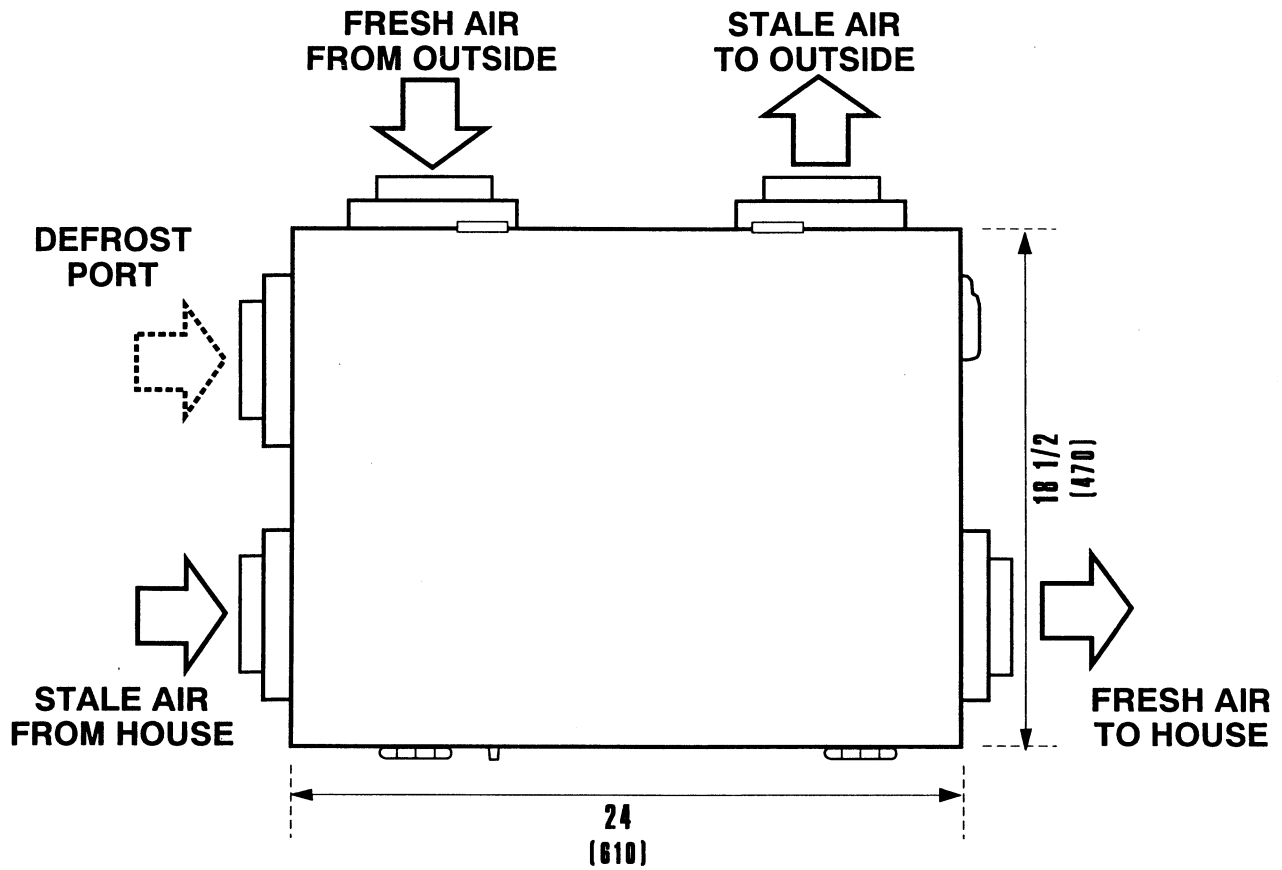

*All Ports 5" (130mm)

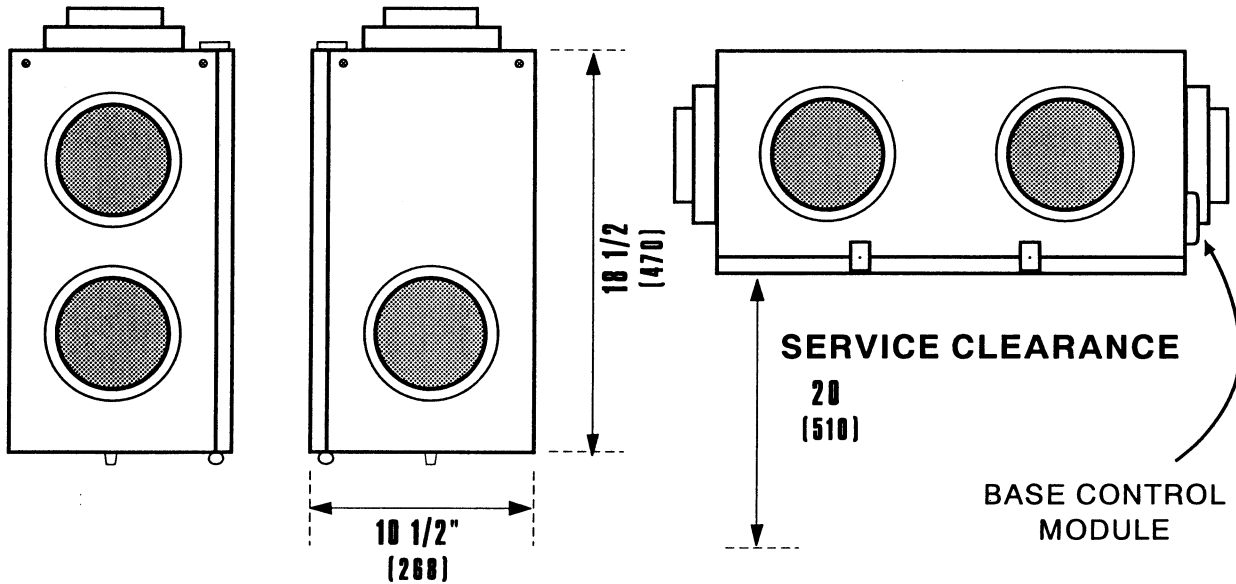

NUTECH
ENERGY SYSTEMS INC.

511 McCormick Blvd.
London, Ontario N5W 4C8
Phone 519-457-1904
Fax 519-457-1676

DATE _____

PROJECT _____

MECHANICAL CONTRACTOR _____

